

Potain - MCT 385

Guide Produit - Ref.: 108 2012 10 5 EN



Characteristics and Key Points

On the MCT 385 crane, everything has been designed in order to optimize, in full safety, the productivity on the site during operation, maintenance, erection/dismantling, as well as during transport and therefore ensuring a profitable investment.

To meet different requirements of market, this topless crane is designed with advanced performances of 20t and 14t, which are perfectly adapted to the heavy duty job site.

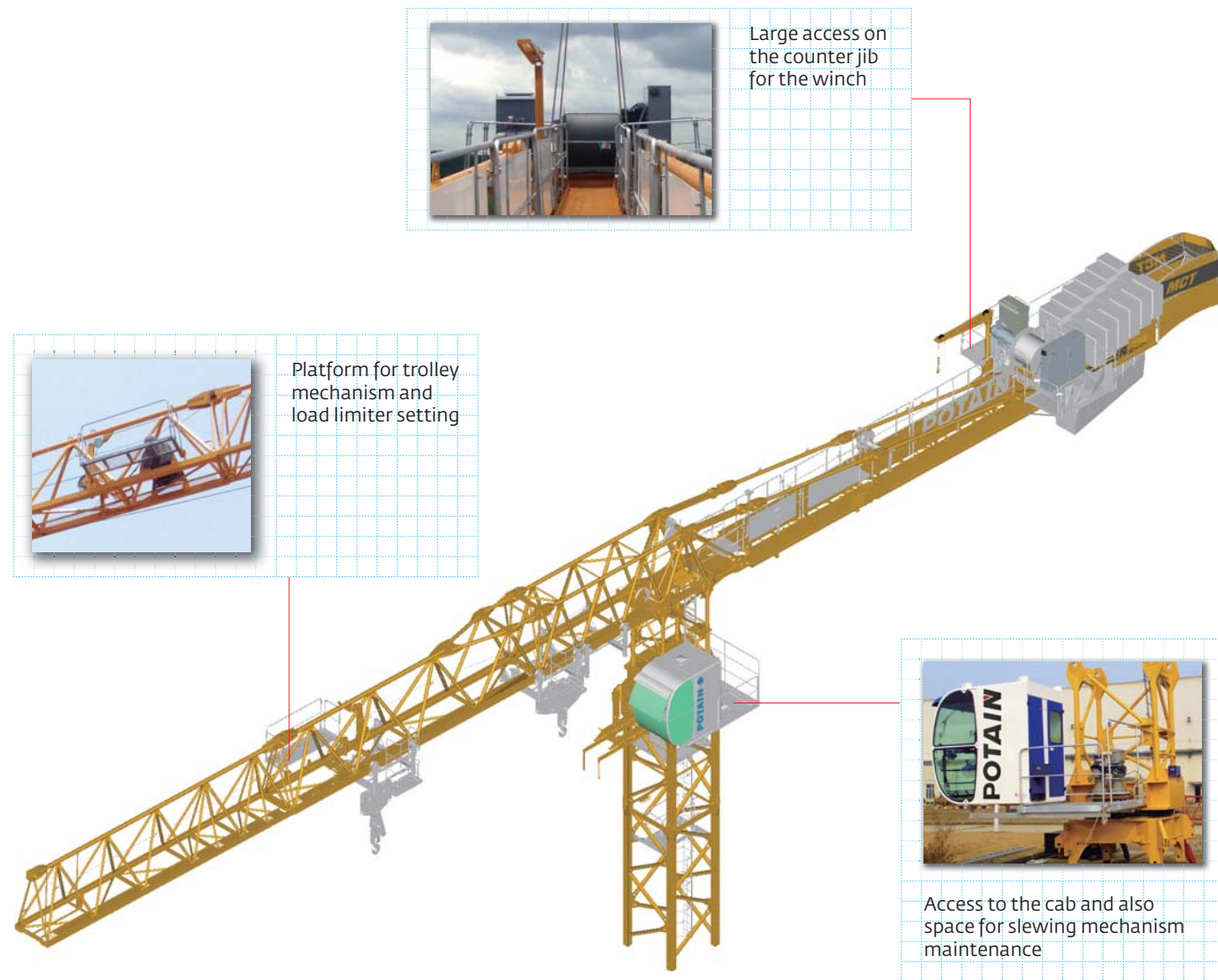

Simple and rapid erection/dismantling

Preparing the packages on the ground is carried out rapidly thanks to the conception of elements

Each part is equipped with slinging points and the package weights are limited (all ≤ 10t)

For the convenience of erecting and dismantling, every jib and mast are built with the lifting eyes



Easy for transportation

Even with its strong capacities, the complete crane - max. 75m & HUH 64,9m - can be easily and rapidly transported in several parts assembled (See page 34-35)

Convenience of transporting the crane to different job sites due to the possibility of preparing the crane in assembled parts before its departure from the site

This type of transportation also offers a considerable saving in time when re-erecting the crane and avoids unprofitable transport operations

Maximum load	20 t	14 t
Maximum jib	75 m	75 m
Load at jib nose	20 t 2,7 t - 75 m jib	14t 3,2 t - 75 m jib
Masts	2 m M mast	2 m M mast
Hoisting	100 hp 20 t at 18 m/min (4 - fall) 10 t at 36 m/min (2 - fall)	75 hp 14 t at 20 m/min (4 - fall) 7 t at 40 m/min (2 - fall) 100 hp 14 t at 26 m/min (4 - fall) 7 t at 52 m/min (2 - fall)
Driving aids	Indicators Control of slewing over forbidden zones & anti-collision system (option)	Indicators Control of slewing over forbidden zones & anti-collision system (option)

Erection Kinematics



Fitting the fixing angles

The new fixing angle template (in option) is stiff, so it is possible to fit the fixing angles only by using this template (no need to add one more mast at the top). The reusable fixing angles exist in option.



Fitting the towerhead/cab

The cab mast together with the turntable:

1. Cabin can be assembled to the sub-assembly on ground
2. Cabin can also be installed in the air after installing the slewing towerhead



Preparation on the ground

Simple and rapid assembling of the jib and counter jib on the ground

Most of the parts are pre-assembled in the factory in order to save time on job site



Fitting the front jib

Thanks to the topless design, no tie bar is required

Jib can be assembled completely or partially in sections on ground

1

2

3

4

5

6

7

8

Fitting the crane tower

1. Fit the mast sections by means of the auxiliary lifting equipment
2. Fit the mast sections by means of telescoping after it is fit to the lowest mast height for telescoping by the auxiliary lifting equipment



Fitting the jib foot

There are two ways of fitting the jib foot:

1. Fit the jib foot to the towerhead
2. Fit the jib foot together with one 10m jib section to the towerhead



Fitting the counter-jib

The counter-jib is fitted onto the jib foot and then locked by means of pins and shafts



Ballasting

Depending on the jib length, partial ballasting may be required

Putting into service

Reeve the wire ropes and adjust the limit switches as well as safety devices
And the crane is ready to work



Preparing the Jib



Every jib section can be lifted by means of the sling points for full safety



Each jib section has a "ladder" to the sling points and to the pins to enhance a safer working condition



Each jib section is delivered with guard rope assembled



Quick fish joints make the jib assembling easier and faster

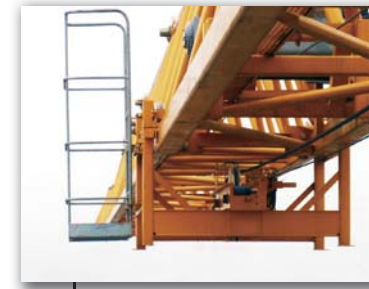

All mechanisms are equipped with the platform for much easier maintenance



The trolley is equipped with the platform for its maintenance and the setting of load limiter

For the convenience of fitting in the air, complete jib is assembled on the ground easily and rapidly

A variable jib adjustable in 5m sections from 30m to 75m with SM/DM trolley (2-fall and 4-fall reeving) or 2C trolley (double trolley)



The walkway is assembled with the access all along the jib for a safer working condition on the jib



Everything is planned to allow the erector to carry out the assembly work easier and safer



Assembling jib sections

By means of the centering pin, the 2 fishplates are fitted easily with each other for inserting the connecting pin
 Fitting the upper pin connection
 Fitting the lower member by means of the centering dowels which serve also for taking up the vertical loads

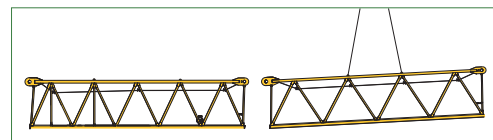

Assembling jib nose

Position the jib nose with centering pins
 Fix the jib nose on the last jib section by means of the screws, washers and nuts

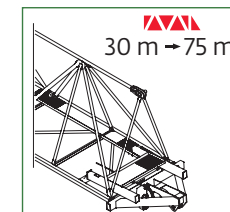

Preparing the Counter-jib

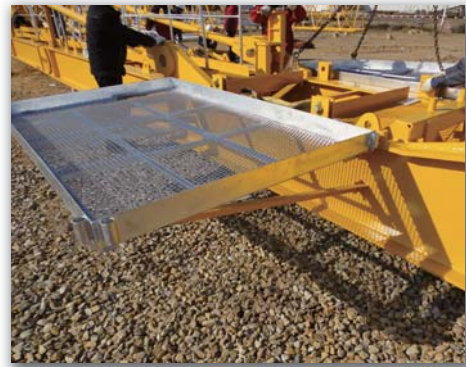

001 Fitting platforms and grab rails

1. For the convenience and safety of operating and maintaining, platforms giving access to the ballast and the hoist winch are assembled and fitted on the counter-jib
2. Fit the grab rails on the platforms and the counter-jib, and then fix them by means of safety pins



002 Fitting hoist winch

1. Fit the hoist winch on the counter jib and fix it by means of the pins and split pins for the three connection holes
2. Use the bolt & nut for the remaining hole to mount the hoist winch firmly on the counter jib
3. The hoist winch can be either mounted on the counter jib firstly on ground, or in the air, depending on the mobile crane capacity



003 Fitting counter-jib extension and tie bar

1. Depending on the jib length used, assemble the extension of counter jib by means of 4 pins and split pins
2. Assemble the tie bar and use support to put in assembly position for erection



004 Fitting wind-sail plates

Depending on the jib length used, assemble the wind-sail plate by means of 2 pins and 2 bolts

Fitting the Towerhead/Cab



001 Preparing the cab

Sling the cab at the 4 slinging points which ensures accurate and rapid positioning of the cab on the towerhead and handling in full safety

Platforms protected by grab rails give the crane driver an access to the driver's stand in full safety

Very simple and rapid pin-connection by means of 2 pins locked by split pins, which gains in time during erection



002 Fitting the cab

Lift the cab and cab support assembly until the support can be pinned to the slewing towerhead using pins and split pins

This can be done on the ground or in the air

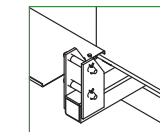

003 Fitting the towerhead

Raise the assembly and position it onto the crane tower by means of intended slinging points

It is possible to slew the crane so that to align jib and counter-jib hold by mobile crane and makes the fitting of the pins much easier

For the convenience and safety of fitting, special accesses are available as option to fit effortlessly the fix pivot pins and the mast pins if the telescoping cage is not used

Fitting the Counter-jib



1

Fitting the towerhead/cab

Overall weight for package (without cab and cab support) is **10t**



2

Fitting the jib foot to the towerhead

- 1 Pin-connecting the jib foot to the towerhead, and fix them by split pins
- 2 Take care that the jib foot must point to the same direction as the cab face
- 3 Overall weight for package (with 2C trolley) is **8,1t**

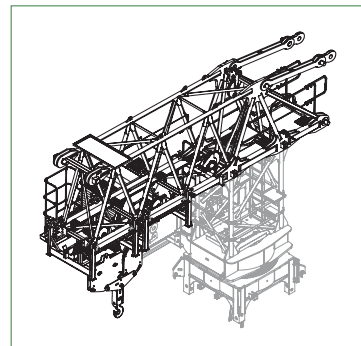

3

Fitting the counter-jib with hoist winch

- 1 Pin-connecting the counter-jib to jib foot
- 2 Overall weight for package without the hoist winch is no more than **10t**



4

Fitting a partial counter ballast

For some jib lengths, before fitting, it is absolutely necessary to carry out a partial ballasting

Fitting the Jib



Fitting the first 30m jib sections N° 2, 3 and 4

1. Pin-connecting the jib sections to jib foot
2. Overall weight for package is no more than **10t**

4



Fitting the rest 40m jib sections

1. Pin-connecting the rest jib sections
2. Overall weight for package is no more than **5,6t**

5

Option 1

Fitting the jib in 2 steps

Fitting the jib

1. Assembly the jib on the ground
2. Fit it to the jib foot by mobile crane
3. Overall weight for full jib package is no more than **15,6t**



Option 2

Fitting the jib in 1 step



Design of the platform and the ladder makes erection much easier and safer



Catwalk along the full jib

Access



Platform for operations at the jib nose



Catwalk and independent safety rope along the full 75m jib give the highest safety to walk along the jib



Large access to the hoisting winch for easy maintaining operation
Every mechanism has one platform for the maintenance operation in order to work in safe conditions



Platform giving access to the jib, allowing also to carry out the operations on the trolley winch and on the load limiter (settings are finished during commission)

1

2

3

4

5

6

This trolley platform allows the maintenance interventions on the jib trolley: working effortlessly in full safety, the technician remains in the crane driver's field of view

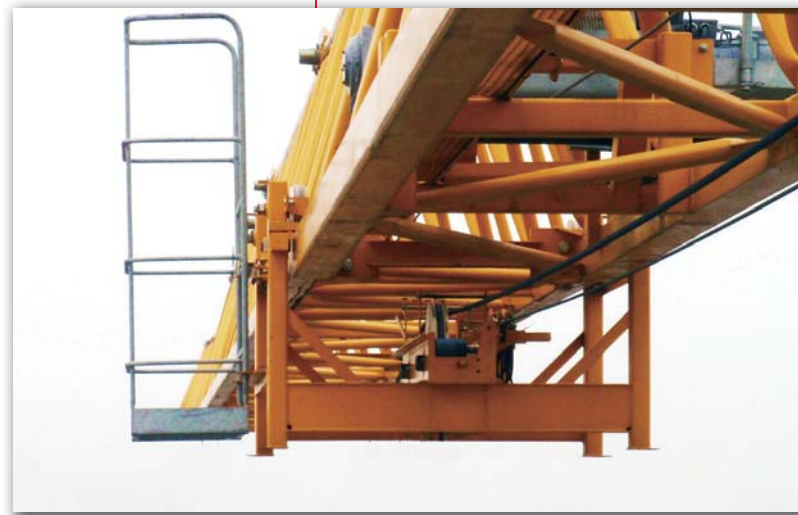

All the erection or maintenance operations are carried out in full safety thanks to the well protected accesses

Rail with special steps (a) as well as the shape of counter ballast (b) are designed for easier and safer access for fitting and dismantling the counter ballast



(a)



(b)

Driving and Maintenance



001 Driving aid devices

Indicator as standard in the driver's cab provide him with all the information he needs: the hook position (height and radius), stresses (load and moment), information on the rope reeving and wind speed. With the DIALOG EASY option, preventive maintenance data also can be displayed

Top Tracing II, as option, combines the control of overslewing forbidden zones (control of 10 zones of maximum 16 points) and the control of interferences between cranes (16 cranes with horizontal or raised jib). Ideal for sites with several cranes in operation



004 Derrick and auxiliary winch

Derrick is delivered in standard configuration to help maintenance operation on the hoisting winch; the auxiliary winch is supplied as option

With a capacity of 990 daN (990 kg), it covers the whole area of the technical zone and allows to lift the various components of the mechanisms

Auxiliary winch is optional and makes easy the dismantling of parts



002 Weathervaning

At the top of the crane: weather vaning button in the cab

At the crane foot: weathervaning button available on the main control panel (cranes without collector)

For cranes equipped with a collector: weathervaning by means of a wired push-button box and emergency stop as option

With collector Without collector

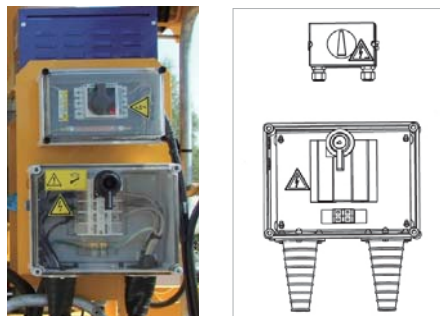

003 Wiring cable option (working height >60m)

The electric wiring included in the standard crane allows a working height of 60 m. For higher working heights it is necessary:

- For cranes with the collector option: To indicate the final working height and to supply the additional multicore cable adapted to the hoisting winch power. The cable cross-section indicated in the price list is calculated for the freestanding height of the crane. For higher heights it is necessary to determine a new cable cross-section (please consult the design department). No extension cord for the version with collector
- For cranes without collector: Adapt the length of the electric wiring by means of the extension cords provided for this purpose according to the power of the supplied hoisting winch

Thanks to the collector the crane can slew in both directions, without any limitation or restriction

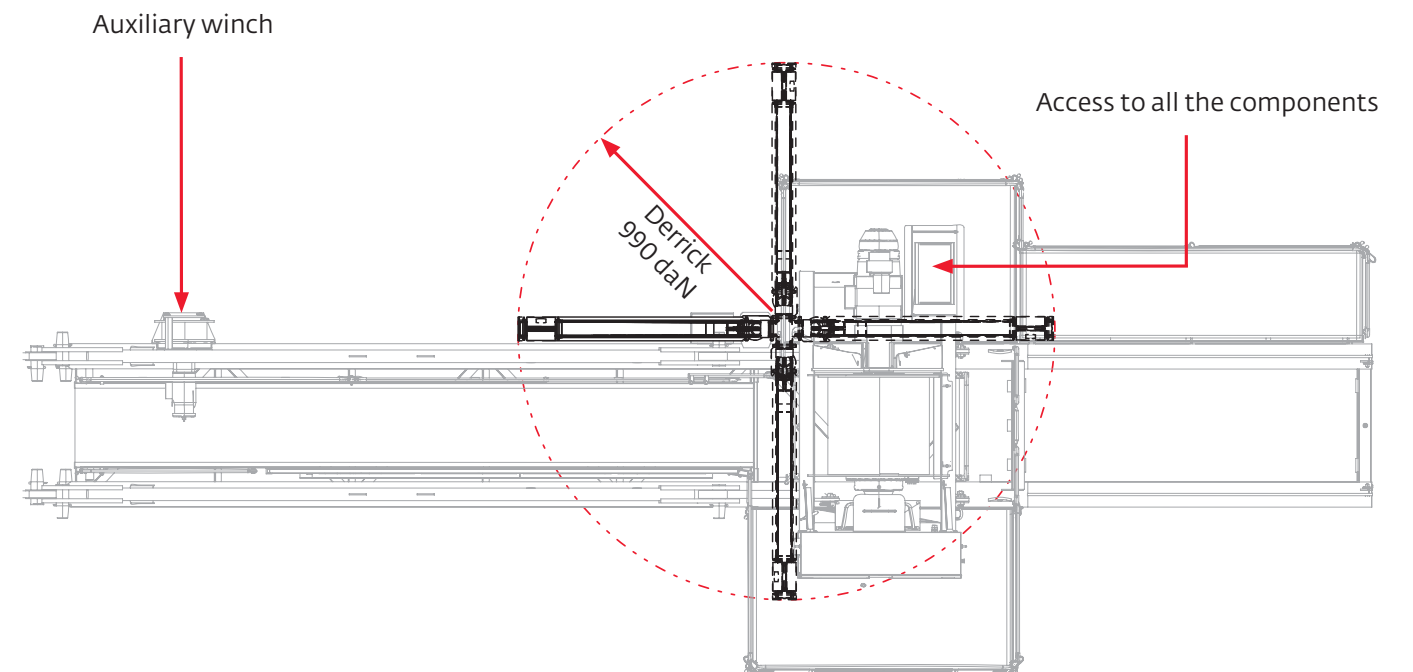

Safety Devices

Wiring Diagram



Upper and lower hoist limit switch



Limit switch «Trolley out» and «Trolley in»



Moment cutout



Load limiter by dynamometric ring



Slewing limiter

For driving in full safety, all the movements are controlled by limiters with deceleration before cutout.

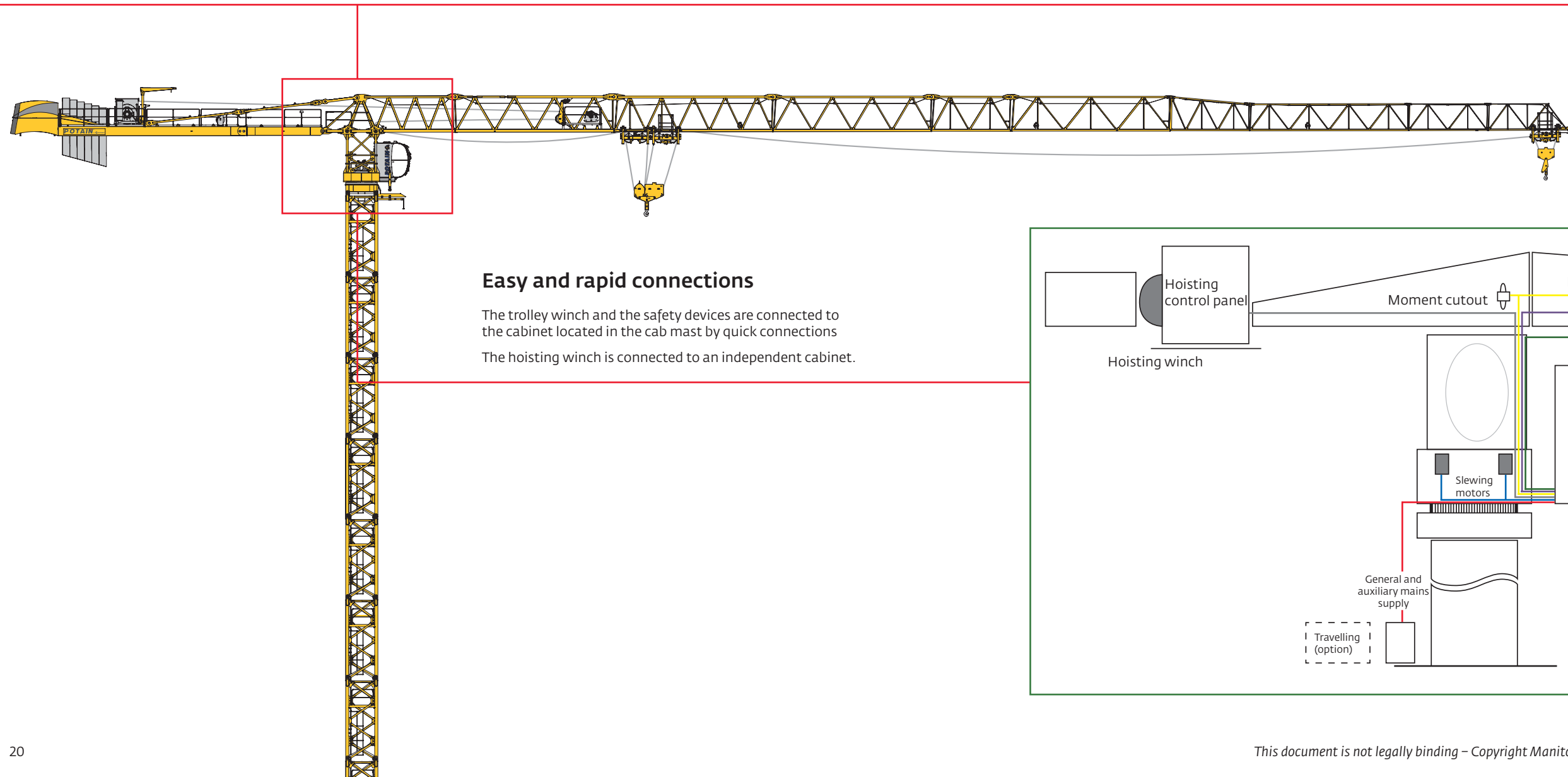

Easy and rapid connections

The trolley winch and the safety devices are connected to the cabinet located in the cab mast by quick connections
The hoisting winch is connected to an independent cabinet.

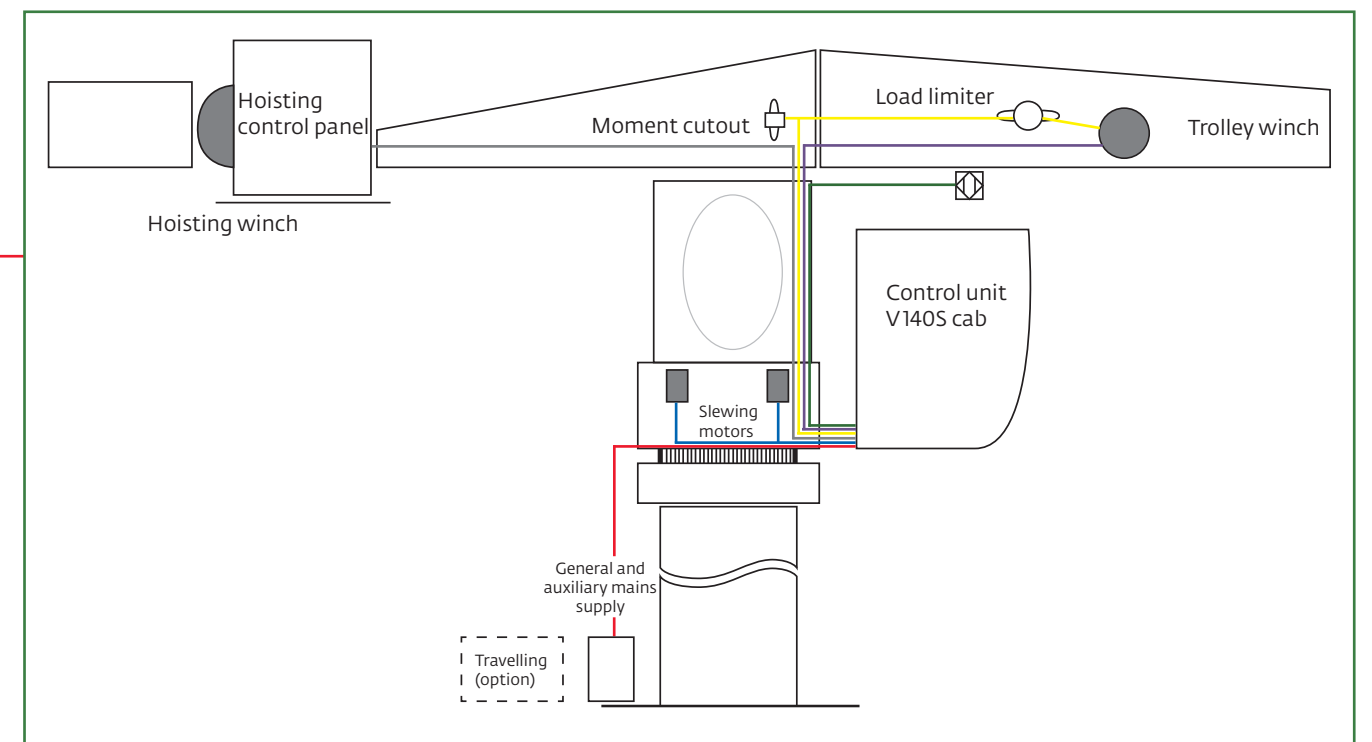

Mechanisms

Accurate mechanisms with frequency variation ensure safe and efficient movements and good productivity on the site.



Hoisting winch **100 LVF 50 Optima (20 t)**
 75 LVF 35 Optima (14 t)
 100 LVF 35 Optima (14 t)

Optimisation of the speed depending on the lifted loads.
 On the first notches (speeds for approaching, tightening the slings.....) speed is controlled by the load limiter (dynamometric ring). Concerning the operating speeds, the Optima system adapts the speed depending on the lifted load. This ensures the winch always runs at full power.



Trolley winch **10 DVF 10 (20 t)**
 6 DVF 6 (14 t)

Progressive speed variation by proportioning control
 The trolley winch is equipped with a frequency converter which supplies the motor with variable frequency and voltage depending on the speed required by the crane driver and the suspended load (3 load cases: max. load, 50% max. load, 25% of max. load).



Slewing mechanism **RVF 172 Optima+ (20 t)**
 RVF 172 Optima+ (14 t)

A completely controlled progressive control
 A speed proportional to the control with in addition a driving adaptable to the crane driver's behaviors:

- either by an action mastered by stopping the control. The jib decelerating time is then controlled by the frequency converter
- or by a reverse control which is possible in the decelerating phase (« counter-slewing control »)

The crane driver controls in this way decelerating and stopping of the motion. The mast torque is always automatically controlled.

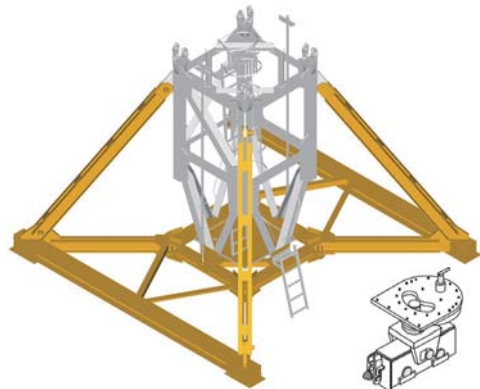

Travelling mechanism **RT 664 A2B - 2V (20 t)**
 RT 664 A2B - 2V (14 t)

Well proven RT type travelling gear is used.
 Cable winders: 50/25 – 60/50 – 110/70 – 140/95 – 170/120 according to the electric cable cross-section and length.

Power supply

20 t

Network	Hoisting winch	Nominal power	Required power	Starting power	Nominal intensity	Starting intensity
400 V - 50 Hz	100 LVF	134 kVA	107 kVA	159 kVA	193 A	229 A
480 V - 60 Hz	100 LVF	139 kVA	107 kVA	164 kVA	167 A	197 A

14 t

Network	Hoisting winch	Nominal power	Required power	Starting power	Nominal intensity	Starting intensity
400 V - 50 Hz	75 LVF	98 kVA	78 kVA	121 kVA	141 A	175 A
	100 LVF	123 kVA	98 kVA	148 kVA	178 A	214 A
480 V - 60 Hz	75 LVF	98 kVA	78 kVA	121 kVA	118 A	146 A
	100 LVF	123 kVA	98 kVA	148 kVA	148 A	178 A

The nominal powers expressed in kVA correspond to the required power of a crane with heavy loads in heavy duty cycles. For operation with not heavy duty cycles, the nominal power can be reduced by 20%.

20 t

400 V - 50 Hz 480 V - 60 Hz		U↑				UU↑				ch - PS hp	kW	🔊	
⬆️	100 LVF 50 Optima	m/min	36	54	86	94	18	27	43	47	100	75	1018 m
		t	10	6	3	2,5	20	12	6	5			
⬅️	10 DVF 10	m/min	0 → 80 (20 t) 0 → 100 (12 t) 0 → 110 (6 t)								10	7,4	
🌀	RVF 172 Optima+	tr/min U/min rpm	0 → 0,8 (400V - 50 Hz) 0 → 1 (480V - 60 Hz)								2 x 10	2 x 7,5	
🔊	VB22 RT 664 A2B - 2V R ≥ 13 m	m/min	16 → 32 (400V - 50 Hz) 19 → 38 (480V - 60 Hz)								4 x 7	4 x 5,2	

Under special request, it is possible to have 150 LVF 50 GH.

14 t

400 V - 50 Hz 480 V - 60 Hz		U↑				UU↑				ch - PS hp	kW	🔊	
⬆️	75 LVF 35 Optima	m/min	40	46	81	96	20	23	41	48	75	55	766 m
		t	7	6	3	2,25	14	12	6	4,5			
⬆️	100 LVF 35 Optima	m/min	52	62	108	140	26	31	54	70	100	75	1146 m
		t	7	6	3	1,75	14	12	6	3,5			
⬅️	6 DVF 6	m/min	0 → 42 (14 t) → 84 (7 t) → 100 (3,5 t)								5,5	4	
🌀	RVF 172 Optima+	tr/min U/min rpm	0 → 0,8 (400V - 50 Hz) 0 → 1 (480V - 60 Hz)								2 x 10	2 x 7,5	
🔊	VB22 RT 664 A2B - 2V R ≥ 13 m	m/min	16 → 32 (400V - 50 Hz) 19 → 38 (480V - 60 Hz)								4 x 7	4 x 5,2	

Data sheets

The technical information contained in this document is useful as a basic introduction to the crane. In no case may this document serve as substitute for the various manuals bearing the machine number of the crane.

2C 4-fall rope reeving

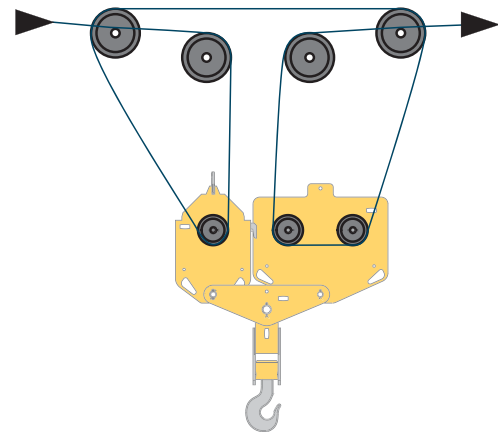

2C 2-fall rope reeving

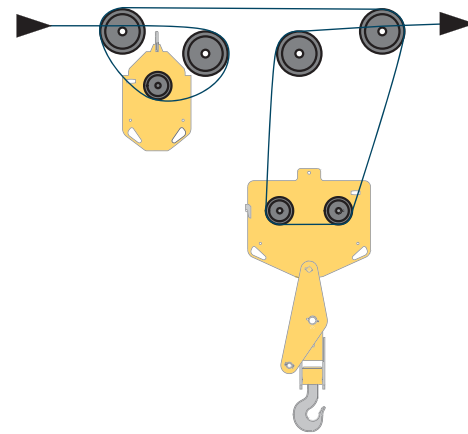

SM/DM 4-fall rope reeving

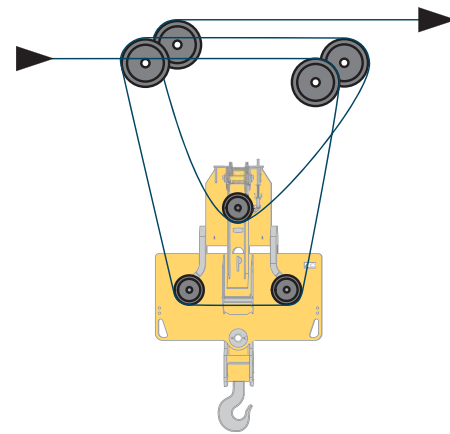

SM/DM 2-fall rope reeving

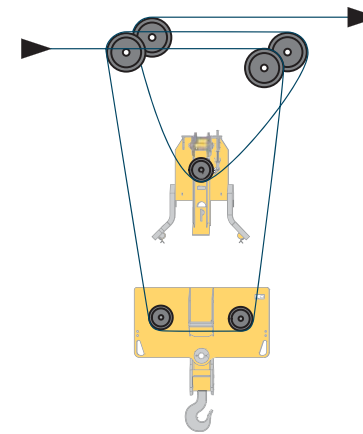

Trolleys and corresponding load curves

2/4-fall reeving 2C trolley equipment (double trolley) is offered as standard. SM/DM trolley equipment is available as an option.



14 t

75 m	3,4	▶	20,4	22	25	27	30	32	35	36	39,6	42	45	47	50	52	55	57	60	62	65	67	70	72	75	m
▲▲▲▲			14	12,8	11	10	8,8	8,1	7,3	7	7	6,5	6	5,7	5,3	5,1	4,7	4,5	4,3	4,1	3,8	3,7	3,5	3,4	3,2	t
70 m	3,4	▶	21,2	22	25	27	30	32	35	37,6	41,1	42	45	47	50	52	55	57	60	62	65	67	70			m
▲▲▲▲			14	13,4	11,5	10,5	9,3	8,6	7,7	7	7	6,8	6,3	6	5,6	5,3	5	4,8	4,5	4,3	4,1	3,9	3,7			t
65 m	3,4	▶	22,1	25	27	30	32	35	37	39,5	43	45	47	50	52	55	57	60	62	65						m
▲▲▲▲			14	12,1	11,1	9,8	9,1	8,1	7,6	7	7	6,6	6,3	5,9	5,6	5,3	5	4,7	4,6	4,3						t
60 m	3,4	▶	23,9	25	27	30	32	35	37	40	42,7	46,4	47	50	52	55	57	60								m
▲▲▲▲			14	13,3	12,1	10,7	9,9	8,9	8,3	7,6	7	7	6,9	6,4	6,1	5,8	5,5	5,2								t
55 m	3,4	▶	24,7	25	27	30	32	35	37	40	42	44,2	48,1	50	52	55										m
▲▲▲▲			14	13,8	12,6	11,2	10,4	9,3	8,7	7,9	7,5	7	7	6,7	6,4	6										t
50 m	3,4	▶	25,4	27	30	32	35	37	40	42	45,4	49,4	50													m
▲▲▲▲			14	13	11,5	10,7	9,6	9	8,2	7,7	7	7	6,9													t
45 m	3,4	▶	26	27	30	32	35	37	40	42	45															m
▲▲▲▲			14	13,4	11,9	11	9,9	9,3	8,4	7,9	7,3															t
40 m	3,4	▶	26,4	27	30	32	35	37	40																	m
▲▲▲▲			14	13,7	12,1	11,2	10,1	9,4	8,6																	t
35 m	3,4	▶	26,7	27	30	32	35																			m
▲▲▲▲			14	13,8	12,2	11,3	10,2																			t
30 m	3,4	▶	26,6	27	30																					m
▲▲▲▲			14	13,8	12,2																					t

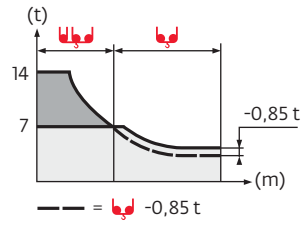

20 t

75 m	3,4	▶	14,5	15	17	20	22	25	25,3	27,8	30	32	35	37	40	42	45	47	50	52	55	57	60	62	65	67	70	72	75	m
▲▲▲▲			20	19,2	16,5	13,5	11,9	10,1	10	10	9,1	8,4	7,6	7,1	6,4	6	5,5	5,2	4,8	4,6	4,2	4	3,8	3,6	3,3	3,2	3	2,9	2,7	t
70 m	3,4	▶	15	17	20	22	25	26,3	28,8	30	32	35	37	40	42	45	47	50	52	55	57	60	62	65	67	70			m	
▲▲▲▲			20	17,2	14,1	12,5	10,7	10	10	9,5	8,8	7,9	7,4	6,7	6,3	5,8	5,5	5,1	4,8	4,5	4,3	4	3,8	3,6	3,4	3,2			t	
65 m	3,4	▶	15,6	17	20	22	25	27	27,5	30	32	35	37	40	42	45	47	50	52	55	57	60	62	65					m	
▲▲▲▲			20	18,1	14,9	13,2	11,3	10,2	10	10	9,3	8,3	7,8	7,1	6,7	6,1	5,8	5,4	5,1	4,8	4,5	4,2	4,1	3,8					t	
60 m	3,4	▶	16,8	20	22	25	27	29	29,7	32,4	35	37	40	42	45	47	50	52	55	57	60								m	
▲▲▲▲			20	16,3	14,5	12,4	11,3	10,3	10	10	9,1	8,6	7,8	7,3	6,8	6,4	5,9	5,6	5,3	5	4,7								t	
55 m	3,4	▶	17,4	20	22	25	27	30	30,7	33,6	35	37	40	42	45	47	50	52	55										m	
▲▲▲▲			20	17	15,1	13	11,8	10,3	10	10	9,5	8,9	8,1	7,7	7,1	6,7	6,2	5,9	5,5										t	
50 m	3,4	▶	17,9	20	22	25	27	30	31,5	34,4	35	37	40	42	45	47	50												m	
▲▲▲▲			20	17,5	15,6	13,4	12,2	10,7	10	10	9,8	9,2	8,4	7,9	7,3	6,9	6,4												t	
45 m	3,4	▶	18,5	20	22	25	27	30	32	32,7	35,7	37	40	42	45														m	
▲▲▲▲			20	18,2	16,3	14	12,7	11,1	10,3	10	10	9,6	8,7	8,3	7,6														t	
40 m	3,4	▶	18,8	20	22	25	27	30	32	33,2	36,2	37	40																m	
▲▲▲▲			20	18,6	16,6	14,2	12,9	11,3	10,5	10	10	9,8	8,9																t	
35 m	3,4	▶	18,9	20	22	25	27	30	32	34	35																		m	
▲▲▲▲			20	18,7	16,7	14,3	13	11,4	10,5	9,8	10																		t	
30 m	3,4	▶	18,8	20	22	25	27	30																					m	
▲▲▲▲			20	18,6	16,6	14,3	13	11,4																					t	

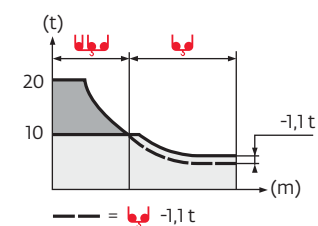

75 m	2,4	▶	20,6	22	25	27	30	32	35	36,6	38,2	42	45	47	50	52	55	57	60	62	65	67	70	72	75	m
▲▲▲▲			14	13	11,1	10,2	9	8,3	7,4	7	7	6,2	5,7	5,4	5	4,8	4,4	4,2	4	3,8	3,5	3,4	3,2	3,1	2,9	t
70 m	2,4	▶	21,4	22	25	27	30	32	35	38,2	39,9	42	45	47	50	52	55	57	60	62	65	67	70			m
▲▲▲▲			14	13,5	11,7	10,7	9,4	8,7	7,8	7	7	6,6	6,1	5,7	5,3	5,1	4,7	4,5	4,2	4,1	3,8	3,7	3,5			t
65 m	2,4	▶	22,2	25	27	30	32	35	37	39,9	41,7	45	47	50	52	55	57	60	62	65						m
▲▲▲▲			14	12,2	11,2	9,9	9,1	8,2	7,7	7	7	6,4	6,1	5,6	5,4	5	4,8	4,5	4,3	4,1						t
60 m	2,4	▶	24,1	25	27	30	32	35	37	40	43,4	45,3	47	50	52	55	57	60								m
▲▲▲▲			14	13,4	12,3	10,9	10,1	9,1	8,5	7,7	7	7	6,7	6,2	5,9	5,6	5,3	5,0								t
55 m	2,4	▶	24,9	25	27	30	32	35	37	40	42	44,9	46,9	50	52	55										m
▲▲▲▲			14	14	12,8	11,3	10,5	9,5	8,9	8,1	7,6	7	7	6,5	6,2	5,8										t
50 m	2,4	▶	25,6	27	30	32	35	37	40	42	46,1	48,2	50													m
▲▲▲▲			14	13,2	11,7	10,8	9,7	9,1	8,3	7,8	7	7	6,7													t
45 m	2,4	▶	26,2	27	30	32	35	37	40	42	45															m
▲▲▲▲			1																							

Data sheets

Jib compositions: MCT 385 is marketed as standard with 75 m jib. The other jib versions are proposed as an option according to the following splitting up:

5 m splitting up

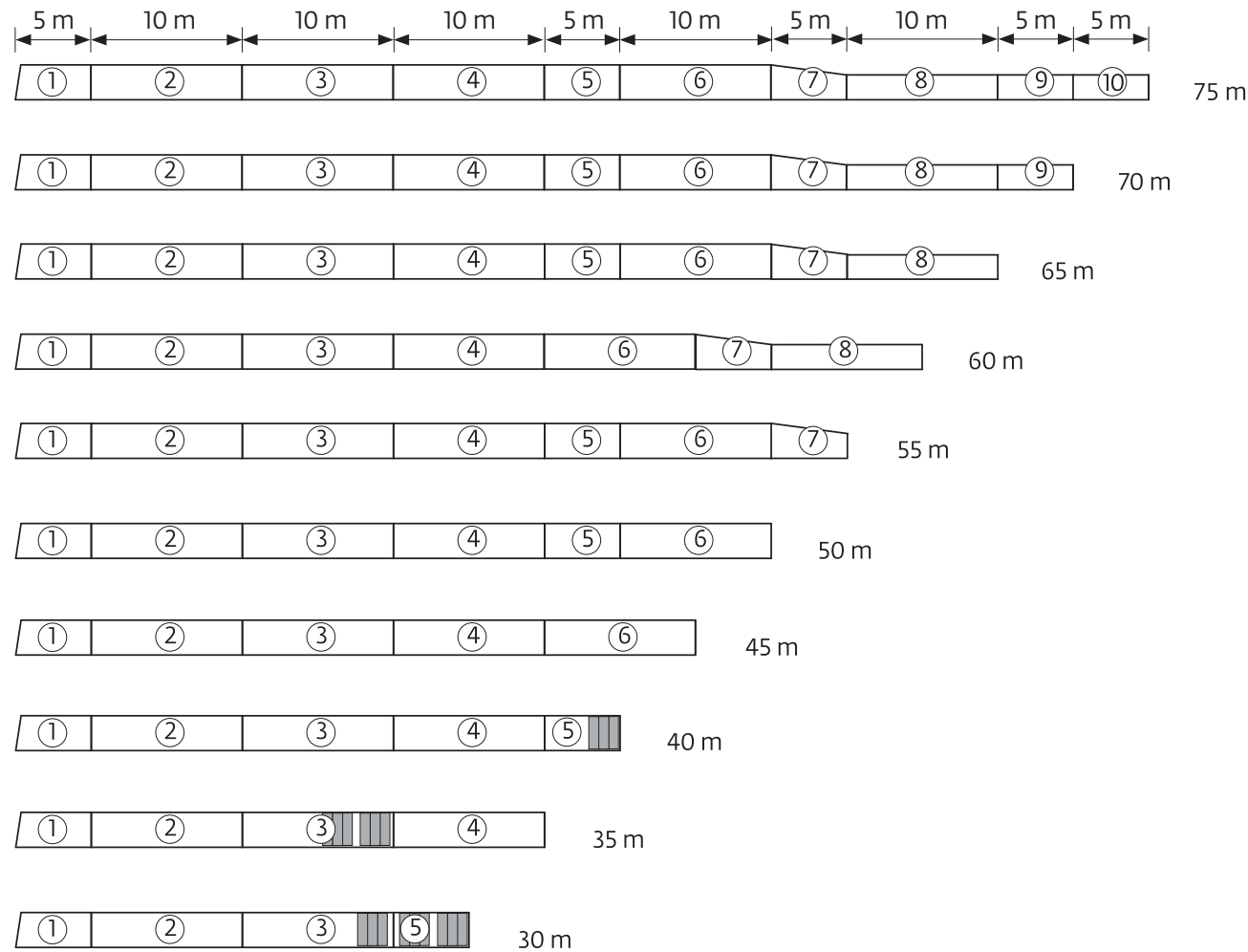

Wind-sail plates

Wind-sail plates

These plates which are essential for the crane stability (in and out of service) are fitted during the erection operations. Their positions varying according to the jib versions must be compulsorily observed and comply with the regulations of the technical instructions of the crane.

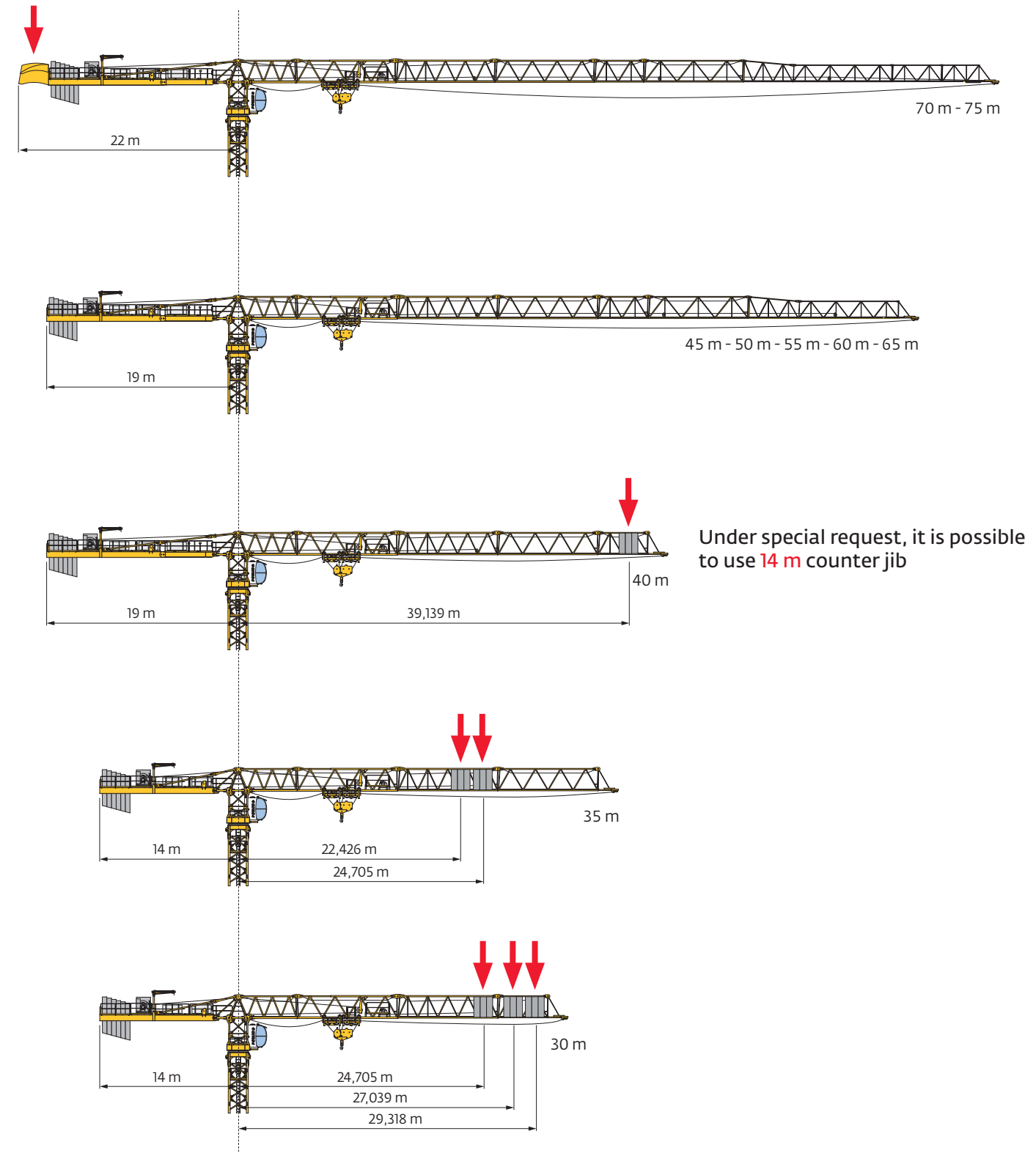

Data sheets

Counter-jib ballast (20 t & 14 t)

▲▲▲	4850 kg	3150 kg	▲ (kg)
75 m	6	0	29 100
70 m	5	1	27 400
65 m	5	1	27 400
60 m	5	0	24 250
55 m	5	0	24 250
50 m	4	1	22 550
45 m	3	2	20 850
40 m	4	0	19 400
35 m	6	0	29 100
30 m	4	2	25 700

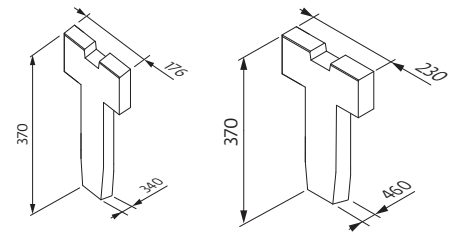

Mast

Masts of « M » type technology, with fish joints with stepped pins and anticorrosive treatment. Inclined access (as option, with Aluminium ladders) and vertical access (standard, with galvanized steel ladder) protected by back loops.

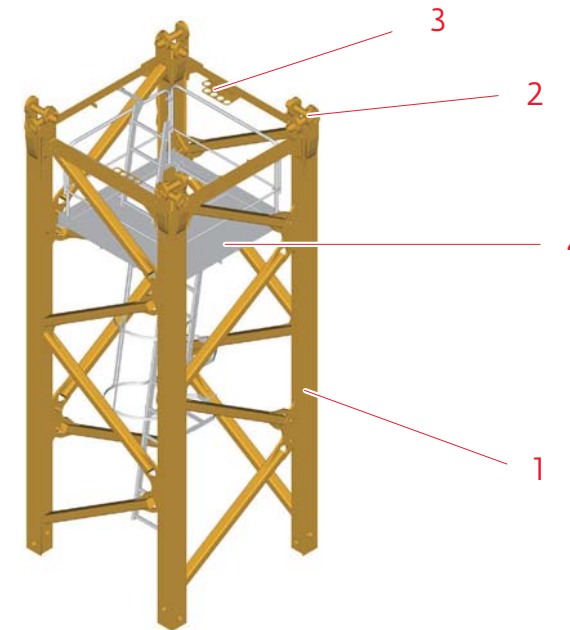

001

Perfect mast adaptation

- Two types of mast:
M 619A - 5m
M 619C - 3,33m
- Cross-section is 2m
- With these 2 masts, the height under hook can be adjusted at every 1,66m
- Rest platform for every mast (option)

Telescoping cage

The use of new telescoping cage on 5m masts can increase the speed of telescoping phase

Weight of telescoping cage is 8t

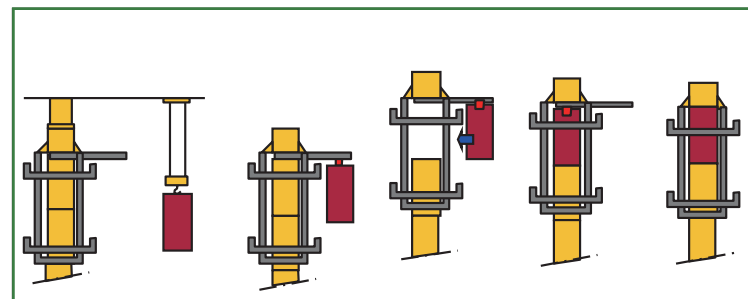

002

Fishing plates

- Optimum mounting by crosswise fitted and stepped pins with 2 diameters
- Locked by means of universal ring and safety pins

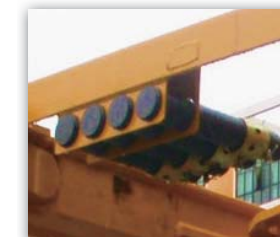

003

Pin supports

- Rigidly fitted to the mast
- Pins: within reach for mounting and dismantling the mast
- Avoid the loss of pins and make storing much easier
- These pin supports can be bolted on the mast at different positions as required



004

Accesses

- Two types of accesses vertical and inclined ladders
- For inclined ladder, every mast is equipped with the ladder and the resting platform
- The platforms are also used for fitting the fish joint pins
- All the accesses are galvanized for long lasting

Data sheets



001 Computerized machining ensures precise dimensions for safe and easy erection as well as long lasting
Pin holes are covered during delivery to keep the holes at the best condition for the assembly at job site



002 The pins with special treatments guarantee an exceptional lifetime without special maintenance
The cross-fitted pins reinforce a perfect rigid fixing which suppresses every micro shifting of the masts with respect to each other and thus minimizes any damage on the bearing surfaces due to friction
TIRAX pin is available as an option.



003 Completely painted outside and inside for maximum anti-corrosion protection
Dismountable mast into panels minimize volume for long distance transportation
Freight cost for the mast could be lowered by a maximum of 2/3 with the use of dismountable panel masts

The fishplating is carried out by means of TREATED STEPPED PINS, whose fitting is SIMPLE - RAPID - EASY and SAFE

The technical information contained in this document is useful as a basic introduction to the crane. In no case may this document serve as substitute for the various manuals bearing the machine number of the crane.

Climbing inside the building

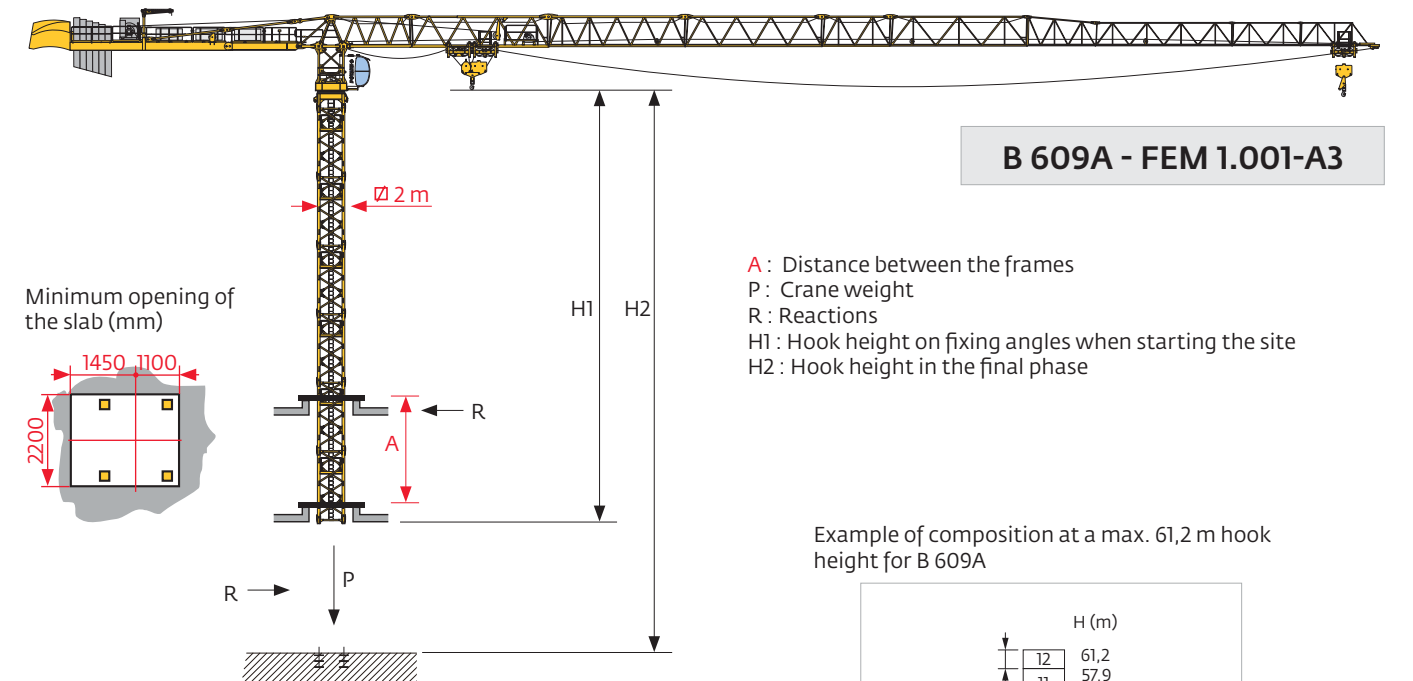

Example of composition at a max. 61,2 m hook height for B 609A

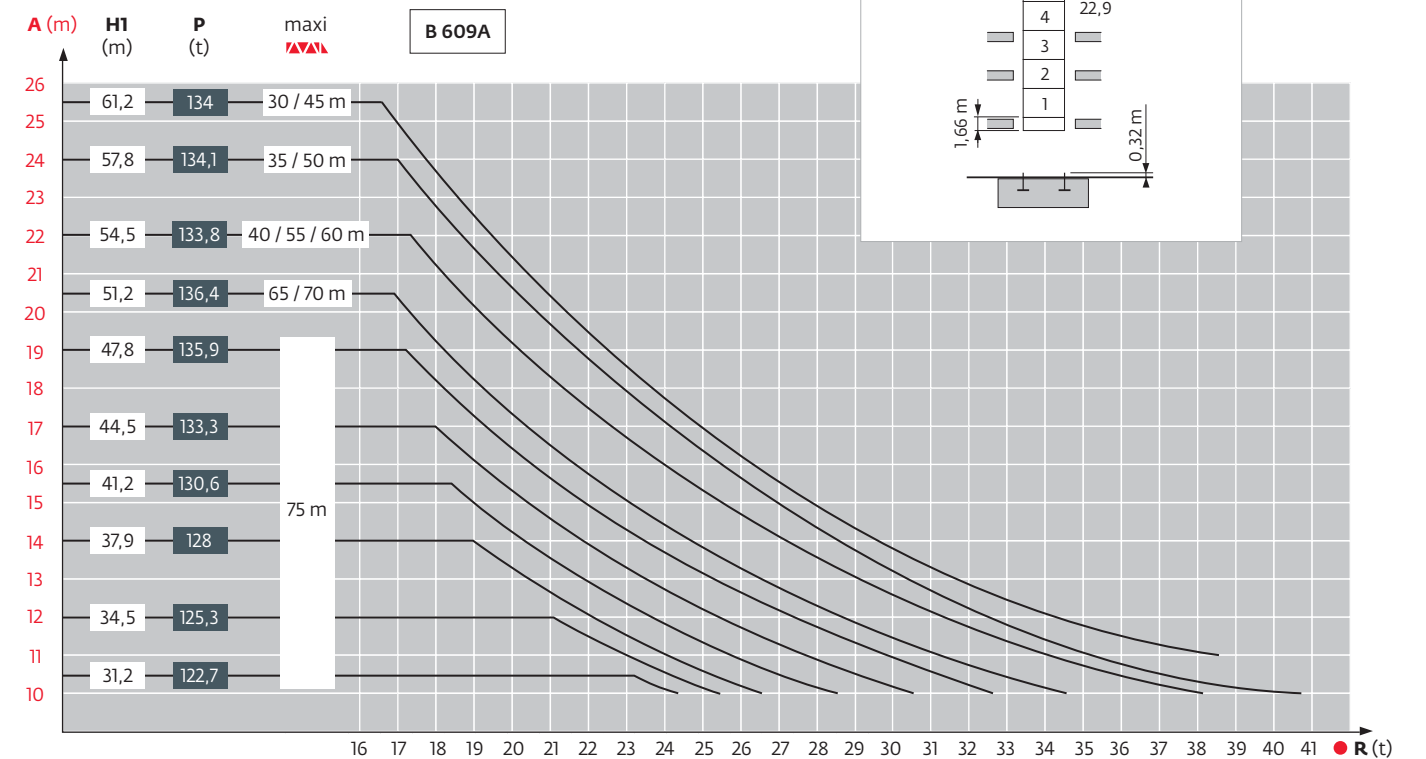
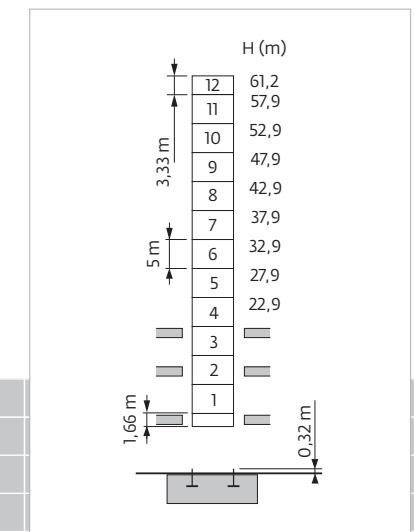

Telescoping on slabs is handled case by case after consultation with the technical sales department.

Data sheets

Mast compositions

H (m) : the hook height (m) is given as an indication. This height depends on the trolley type used (SM/DM or 2C) and the type of crane base (fixing angle or chassis). See the data sheets for the exact definition of the hook height according to the configuration. It's possible to replace two 5 m mast sections by three 3,33 m mast sections.

The cast-in fixing angles cannot be reused. They are set in the concrete block.
The reusable fixing angles are fitted on the concrete block and mounted by anchorage rods (customer's supply).
A template frame (option) is used for perfect fitting of the fixing angles or reusable fixing angles.

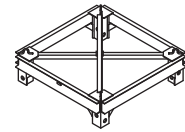

Non-reusable fixing angles P 22

2 m
Fish joint Ø 70 mm

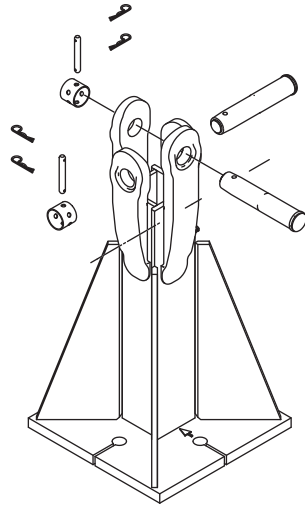

Reusable fixing angles R 22

2 m
Fish joint Ø 70 mm

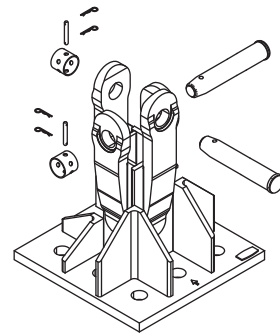

2 m telescopic

30 m → 75 m

P 22 - FEM 1.001-A3			
H (m)	M 619C	M 619A	
D70	3,33 m	5 m	
64,9	1	12	
61,5	0	12	
56,5	0	11	
51,5	0	10	
46,5	0	9	
41,5	0	8	
36,5	0	7	
31,5	0	6	
26,5	0	5	
21,5	0	4	

R 22 - FEM 1.001-A3			
H (m)	M 619C	M 619A	
D70	3,33 m	5 m	
65,1	1	12	
61,7	0	12	
56,7	0	11	
51,7	0	10	
46,7	0	9	
41,7	0	8	
36,7	0	7	
31,7	0	6	
26,7	0	5	
21,7	0	4	

Chassis VB 22 - 2 m

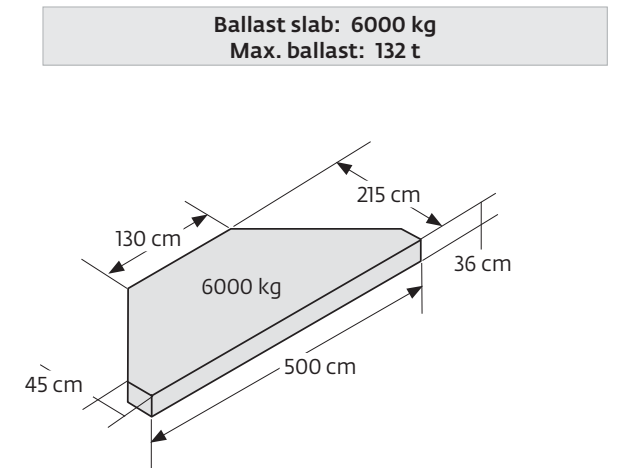
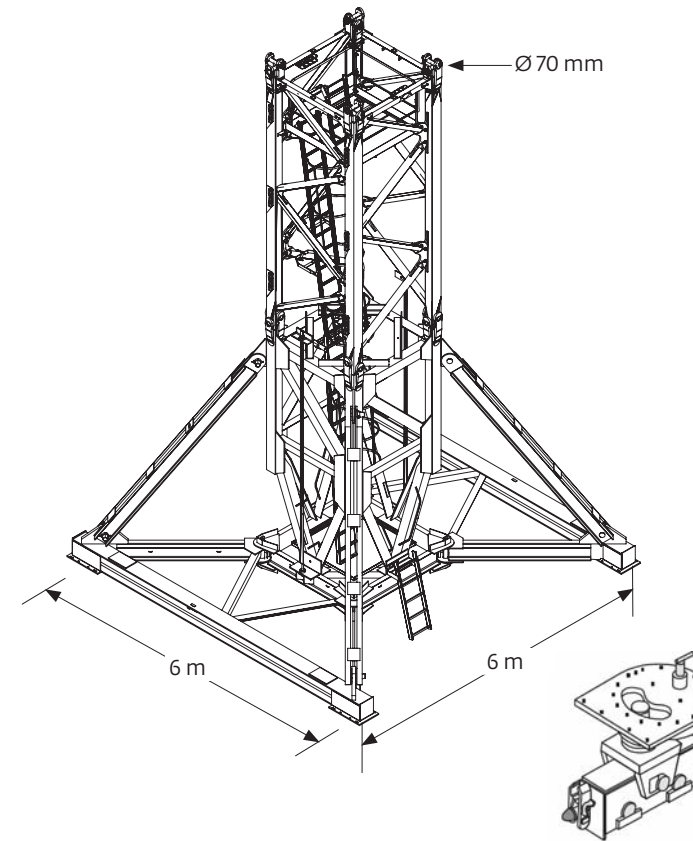

2 m telescopic
30 m → 75 m

VB 22 - FEM 1.001-A3			
H (m)	M 619C	M 619A	
D70	3,33 m	5 m	
63,3	2	10	
60,0	1	10	
56,6	0	10	
51,6	0	9	
46,6	0	8	
41,6	0	7	
36,6	0	6	
31,6	0	5	
26,6	0	4	
21,6	0	3	
16,6	0	2	
11,6	0	1	

Curved track equipment (option) : essential for travelling on curved track.
2 rotating plates, located between the chassis and the bogies, at the opposed corners. The two other bogies are not equipped. When carrying out a curved track, the track width varies in the curve. The system allows that the wheels remain on the track.

Base ballast

VB 22 D70 2 m telescopic	FEM 1.001-A3	H (m)	Ballast (t)												
			63,3	60,0	56,6	51,6	46,6	41,6	36,6	31,6	26,6	21,6	16,6	11,6	
		D70	132	120	108	96	96	96	96	96	96	96	96	96	96

Data sheets

Road transport - Standard truck 13,4 m

Example of loading plan for the complete crane with HUH 61,5m, max. 75 m jib, 2C trolley, 100 LVF hoist winch, 12 M619A masts.

Complete crane can be delivered by 10 standard truck or 10 containers (9 high cube 40' containers & 1 flat rack container). The packaging may be slightly changed according to the actual crane configuration.

10 trucks

1. Equipped towerhead, cab, trolley, fixing angle and pulley block

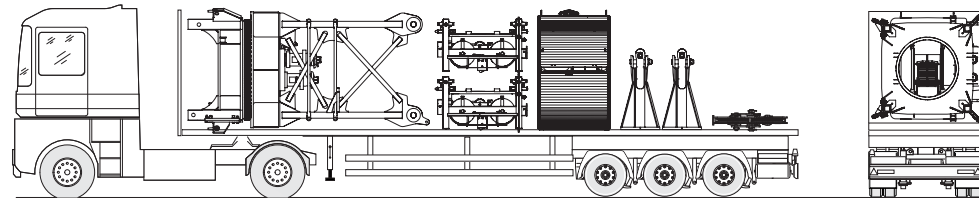

2. Equipped counter-jib

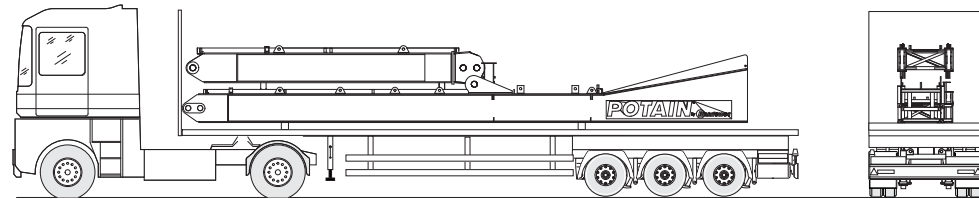

3. Jib section N°1 - 5 m and hoist winch - 100 LVF 50

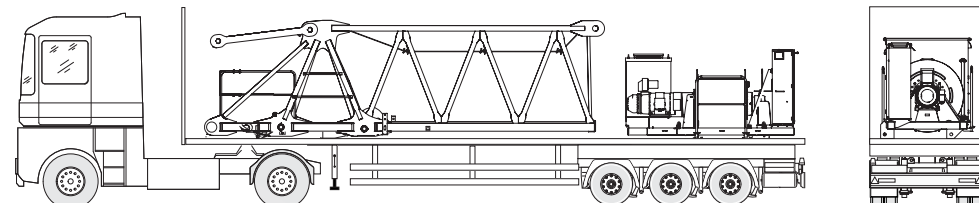

4. Jib sections N°2 - 10 m, access, tool kits and template

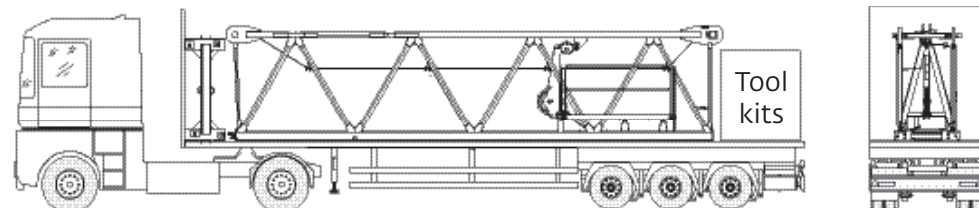

5. Jib sections N°3, N°6 (2 x 10 m) - 20 m and hydraulic unit

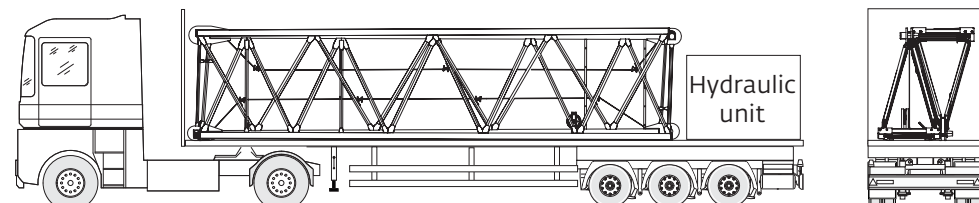

The technical information contained in this document is useful as a basic introduction to the crane. In no case may this document serve as substitute for the various manuals bearing the machine number of the crane.

Maritime transport - High cube 40' container & Flat rack container

Example of containerizing for the complete crane with HUH 61,5m, max. 75 m jib, 2C trolley, 100 LVF hoist winch, 12 M619A masts.

Complete crane can be delivered by 10 standard truck or 10 containers (9 high cube 40' containers & 1 flat rack container). The packaging may be slightly changed according to the actual crane configuration. Telescoping cage and wind-sail assembly are transported by flat rack container.

10 containers

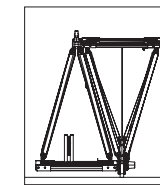
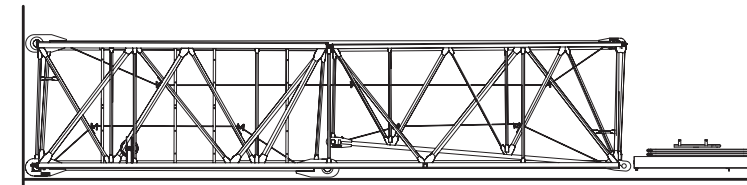

6. High cube 40' container Jib sections N° 4, N° 5 and N° 7 (1 x 10 m + 2 x 5 m) - 20 m, access and platform

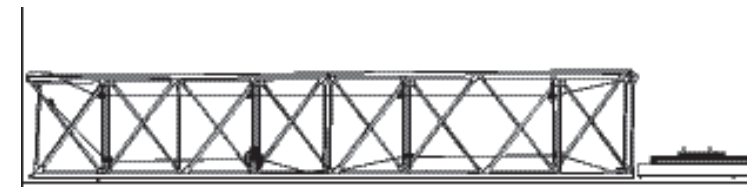

7. High cube 40' container Jib sections N° 8, N° 9 and N° 10 (1 x 10 m + 2 x 5 m) - 20 m, access and cylinder

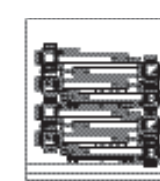
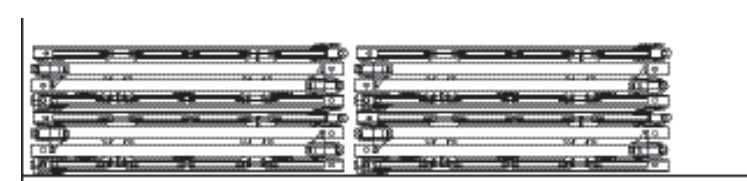

8. High cube 40' container Panel mast M 619A * 6

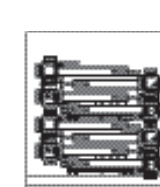

9. High cube 40' container Panel mast M 619A * 6

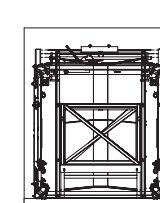
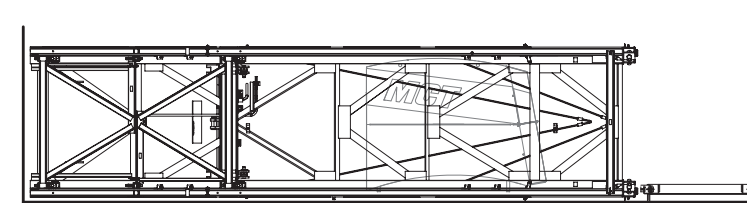

10. Flat rack container Telescoping cage and yoke, wind-sail assembly and cab support

Manitowoc Cranes

Regional headquarters

Americas

Manitowoc, Wisconsin, USA
Tel: +1 920 684 6621
Fax: +1 920 683 6277

Europe, Middle East, Africa Ecully, France

Tel: +33 (0)4 72 18 20 20
Fax: +33 (0)4 72 18 20 00

China

Shanghai, China
Tel: +86 21 6457 0066
Fax: +86 21 6457 4955

Greater Asia-Pacific Singapore

Tel: +65 6264 1188
Fax: +65 6862 4040

Shady Grove, Pennsylvania, USA

Tel: +1 717 597 8121
Fax: +1 717 597 4062

Regional offices

Americas

Brazil
Alphaville
Mexico
Monterrey
Chile
Santiago

Europe, Middle East, Africa

France
Baudemont
Cergy
Decines
Germany
Langenfeld
Italy
Lainate
Netherlands
Breda
Poland
Warsaw
Portugal
Baltar
Russia
Moscow
South Africa
Johannesburg
U.A.E.
Dubai
U.K.
Buckingham

China

Beijing
Chengdu
Guangzhou
Xian

Greater Asia-Pacific

Australia
Brisbane
Melbourne
Sydney
India
Chennai
Delhi
Hyderabad
Pune
Korea
Seoul
Philippines
Makati City
Singapore

Factories

Brazil
Passo Fundo
China
TaiAn
Zhangjiagang
France
Charlieu
Moulins
Germany
Wilhelmshaven
India
Pune
Italy
Niella Tanaro
Portugal
Baltar
Fânzeres
USA
Manitowoc
Port Washington
Shady Grove

This document is non-contractual. Constant improvement and engineering progress make it necessary that we reserve the right to make specification, equipment, and price changes without notice. Illustrations shown may include optional equipment and accessories and may not include all standard equipment.